



KIT CONTAINS

WALL MOUNTED DRAIN
WITH GLASSLINE
MULTI DIRECTIONAL OUTLET
HIGHLINE CUSTOM

5002.0908 | 5003.0908 Glassline Module

For right-aligned shower screen

For left-aligned shower screen



ITEM NUMBER R

5002.0908

ITEM NUMBER L

5003.0908

Specifications

MATERIAL	SURFACE	FLOORING
1,5 mm stainless steel (AISI 304)	Pickled	Tiles
MEMBRANE	FLOOR CONSTRUCTION	INSTALLATION WIDTH (A)
Liquid or sheet membrane	Concrete/wood	901 mm
INSTALLATION DEPTH (B)	CENTRE (C)	SHOWER SCREEN SIZE (D)
901 mm	451 mm	800 mm



1416.0050 - Multi Directional Outlet

Line 1416.0050

Ø 50 mm horizontal drain

Can be rotated 180 degrees if a rear-facing outlet is required.

Note two drains. Cannot be used as an inlet.



Specifications

ITEM NUMBER	GTIN NUMBER	WEIGHT INCLUDING PACKAGING
1416.0050	5707692012520	505 g
WEIGHT EXCLUDING PACKAGING	MATERIAL	USAGE
312 g	Plastic (PP)	Line drain
BARRIER	GASKET	CAPACITY
With	EPDM	0,8 l/s
SIDE INLET	CENTER	FITS DRAIN UNIT
Without	32 mm	1001, 1002, 1003, 1004, 1100, 3002, 3004, 5002, 5003, 4004

FITTING HEIGHTS - LINE FAUCETS 1001, 1002, 1003, 1004

Ø	Outlet direction	300	600	700	800	900	1000	1200
Ø 50 mm	Horizontal	98 mm	102 mm	103 mm	104 mm	105 mm	106 mm	108 mm

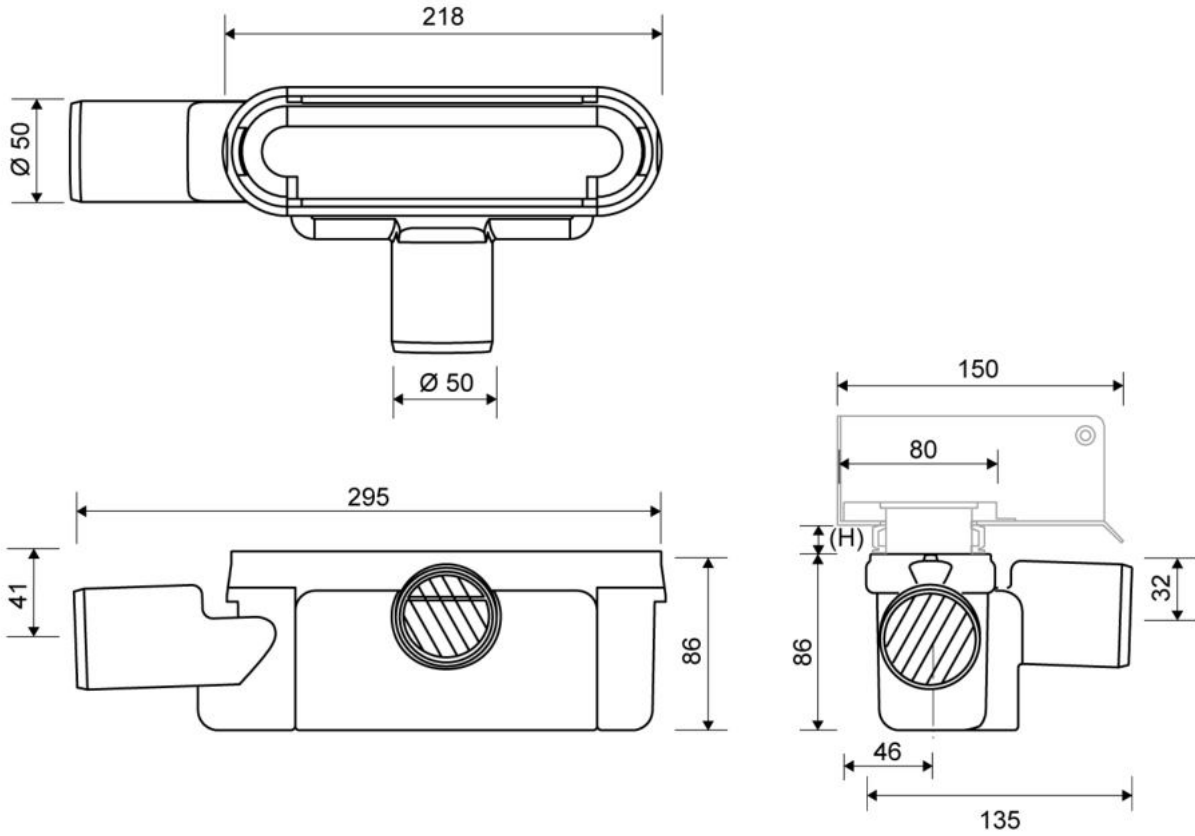

1950.0900 - 900mm Custom Solution

HighLine | Custom

The set consists of the Custom base, rail, heightener set and screws. The set must be assembled before installation.

Glue your own floor tile to the base, to complete the solution.

The Custom solution is placed directly inside the drain unit. The rail is specially designed to provide a snug fit.

Special glue for adhesion of your own tile and 10 x 6-mm spacers to use for installation are also included.

HighLine products cannot be used with 1004-drain units with side outlet.



Specifications

ITEM NUMBER	GTIN NUMBER	WEIGHT INCLUDING PACKAGING
1950.0900	5707692005355	2060 g
WEIGHT EXCLUDING PACKAGING	MATERIAL	USAGE
1970 g	Stainless steel (AISI 304)	Line drain
SURFACE	LENGTH MODEL	HEIGHTENER SET
Brushed	900 mm	Plastic (PE)
LENGTH WITH/WITHOUT FRAME		
833/895 mm		

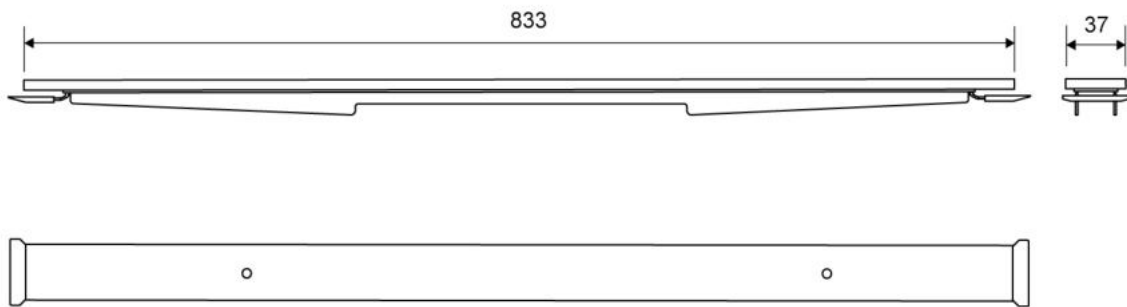

1950.0900

Products

5100.0800

GlassLine | Right and left-aligned shower screen

Design: Transparent

10 mm safety glass

No visible screws or fittings in the finished result

The glass surface is treated with Cleantec nanotechnology, making it water-repellent, less susceptible to limescale and easier to clean.



Specifications

ITEM NUMBER	LENGTH MODEL	HEIGHT (H)
5100.0800	800 mm	2104 mm
DESIGN	MATERIAL	
Transparent	Stainless steel (AISI 304) 10 mm safety float glass	

